

LTC3672BEDC-2: Monolithic Fixed-Output 400mA Buck Regulator with Dual 150mA LDOs in 2mm X 2mm DFN

DESCRIPTION

Demonstration Circuit 1324A is a monolithic 400mA Buck regulator, with fixed output, and two 150mA, Low Drop Out linear regulators. These are housed in an 8 lead, 2mm X 2mm DFN package.

Design files for this circuit board are available. Call the LTC factory.

LT, LTC, LTM, LT, Burst Mode, OPTI-LOOP, Over-The-Top and PolyPhase are registered trademarks of Linear Technology Corporation. Adaptive Power, C-Load, DirectSense, Easy Drive, FilterCAD, Hot Swap, LinearView, μ Module, Micropower SwitcherCAD, Multimode Dimming, No Latency $\Delta\Sigma$, No Latency Delta-Sigma, No R_{SENSE} , Operational Filter, PanelProtect, PowerPath, PowerSOT, SmartStart, SoftSpan, Stage Shedding, SwitcherCAD, ThinSOT, UltraFast and VLDO are trademarks of Linear Technology Corporation. Other product names may be trademarks of the companies that manufacture the products.

PERFORMANCE SUMMARY Specifications are at $T_A = 25^\circ\text{C}$

SYMBOL	PARAMETER	CONDITIONS	MIN	TYP	MAX	UNITS
VIN	Input voltage		2.9		5.5	V
VOUT1	Output of regulator (buck) 1	$I_{OUT1} \leq 400\text{mA}$	1.17		1.23	V
VOUT2	Output of LDO1	$I_{OUT2} \leq 150\text{mA}$. Subject to dropout limitations.	2.73		2.87	V
VOUT3	Output of LDO2	$I_{OUT3} \leq 150\text{mA}$	1.755		1.845	V

OPERATING PRINCIPLES

The LTC3672BEDC-2 is a monolithic fixed output, 400mA, synchronous buck regulator and two 150mA LDOS.

VOUT1 is driven by a high efficiency synchronous buck regulator with a fixed output of 1.2V. The buck regulator on the LTC3672BEDC-2 operates at approximately 2.25MHz, allowing the use of small inductors and capacitors.

The two fixed output LDOs, have a maximum dropout voltage of 250mV, over process and temperature. This allows all three outputs to remain in regulation with VIN as low as 2.98V.

All of the regulators on the LTC3672BEDC-2 are enabled via the ENALL pin, controlled by JP1.

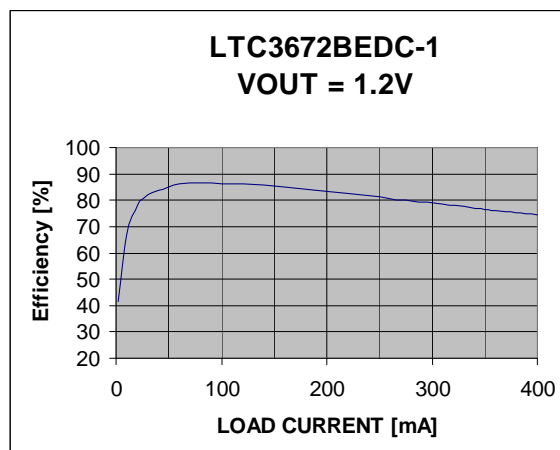

Efficiency of the Buck regulator at VIN = 3.6V

QUICK START GUIDE FOR DEMONSTRATION CIRCUIT 1324A FIXED-OUTPUT 400mA BUCK REGULATOR WITH DUAL 150mA LDOS

LTC3672BEDC-2

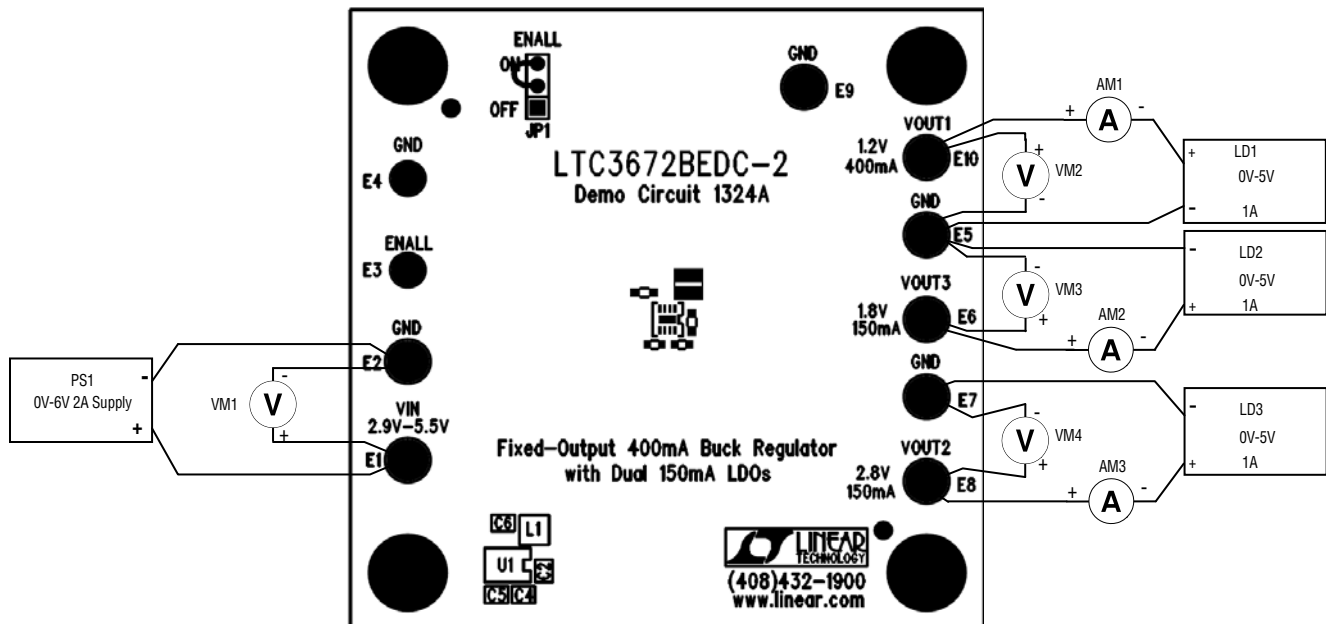
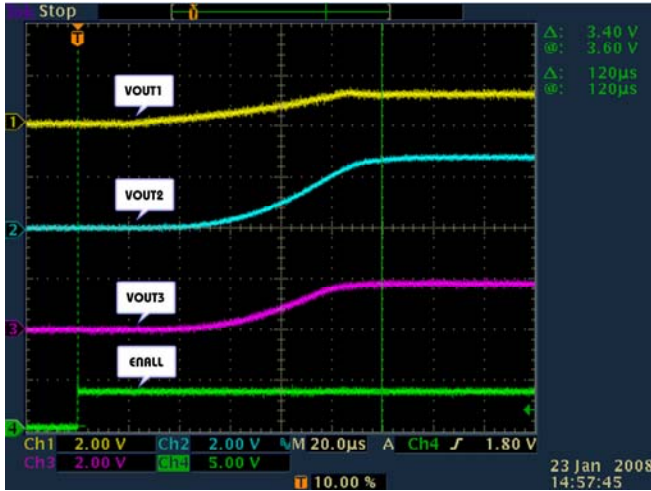

Figure 1: Test Equipment Hookup Diagram

- 1) Connect test equipment as shown in Figure 1. Set PS1 = 0V, set PS1 Ilimit = 1A, set LD1 = 0A, LD2 = 0A, LD3 = 0A, and JP1 = ON.
- 2) Slowly increase PS1 and verify that all regulators are operational at $V_{IN} \geq 2.9V$.
- 3) Set PS1 = 3.6V, and JP1 = ON. Verify VM2 = 1.17V~1.23V, VM3 = 1.755V ~ 1.845V, and VM4 = 2.73V~2.87V.
- 4) Set PS1 = 2.9V, LD1 = 400mA. Verify VM2 = 1.17V~1.23V.
- 5) Set LD2 = 150mA, LD3=150mA. Verify that VM3 = 1.755V~1.845V, and VM4 = 2.65~2.87V.
- 6) Set PS1 = 5.5V, and repeat step 5.
- 7) Set JP1 = OFF, set PS1 = 2.9V, verify that all output voltages (VM2-4) are 0V.
- 8) Set PS1 = 5.5V, verify that all output voltages (VM2-4) are 0V.
- 9) Set PS1 = 0V, set JP1 = ON.

QUICK START GUIDE FOR DEMONSTRATION CIRCUIT 1324A
 FIXED-OUTPUT 400MA BUCK REGULATOR WITH DUAL 150MA LDOS

LTC3672BEDC-2



Oscilloscope 1: Startup from ENALL

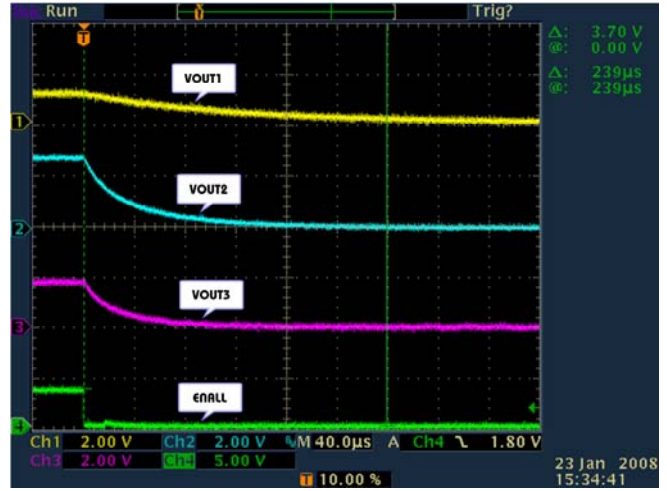

Oscilloscope 2: Shutdown from ENALL

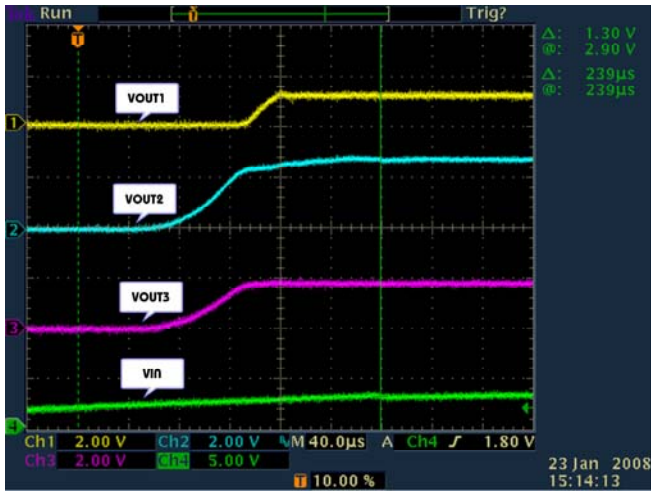

Oscilloscope 3: Startup from VIN

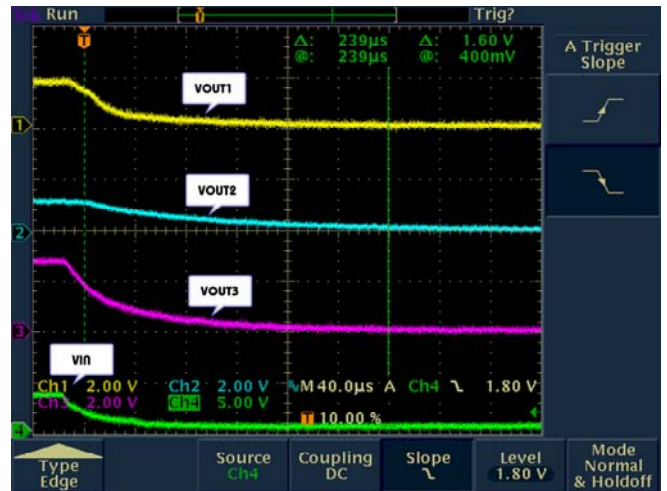

Oscilloscope 4: Shutdown from VIN

APPLICATIONS INFORMATION

There are several components that are only necessary under certain conditions. C1, C3, and R1, need to be used as follows.

The connection of VIN to an operating supply may have significant parasitic inductance. When this connection is made to the DC1324A PCB, the supply must charge up the local decoupling capacitance, C2. A current is established in the connecting leads, while this capacitor is charging. This current acts as a step load to induce ringing in the connection. This ringing may cause the voltage at VIN to rise to up to 2X the supply voltage, possibly damaging devices, including the LTC3672BEDC-2, on the DC1324A board. To prevent this, the damping network composed of C1&R1 has been added. R1 serves to reduce the Q of the resonant circuit, and reduces overshoot on VIN from resonant ringing. C1 blocks the DC voltage, preventing R1 from consuming any DC current.

If the connection between VIN and the power supply is very short, and has very low parasitic inductance, there is no need for this damping circuit, and it may be omitted. This is usually the case when the LTC3672BEDC-2 resides on the same PCB as the source of the VIN voltage. Please be careful with battery wiring that supplies VIN, as this may also have significant parasitic inductance.

C3 provides a decoupling function, in the event that some parasitic resistance and inductance exists between VIN and VIN1. This impedance can be problematic when the LTC3672BEDC-2 is supplying current to loads that contain high speed transients. If, in the application, a direct connection is made to VIN1, then it is unlikely that C3 will be needed.

QUICK START GUIDE FOR DEMONSTRATION CIRCUIT 1324A
 FIXED-OUTPUT 400mA BUCK REGULATOR WITH DUAL 150mA LDOS

LTC3672BEDC-2

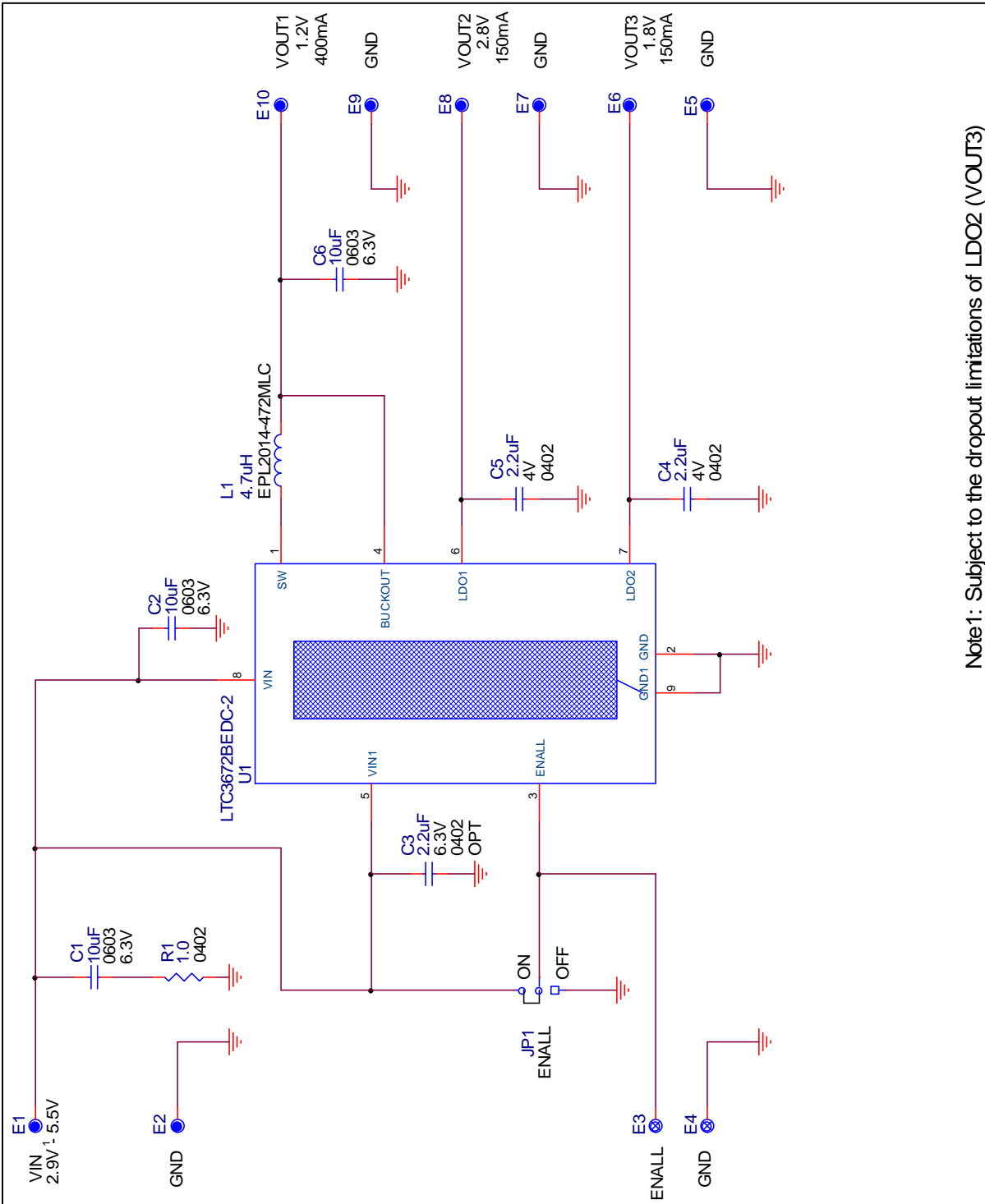

Note1: Subject to the dropout limitations of LDO2 (VOUT3)

Figure 2: Schematic of DC1324A: LTC3672BEDC-2 Monolithic Fixed-Output 400mA Buck Regulator with Dual 150mA LDOs in 2mm X 2mm DFN

QUICK START GUIDE FOR DEMONSTRATION CIRCUIT 1324A FIXED-OUTPUT 400MA BUCK REGULATOR WITH DUAL 150MA LDOS

LTC3672BEDC-2

Linear Technology Corporation

LTC3672BEDC-2

Bill Of Material
Demo Circuit #DC1324A

12/6/2007

Item	Qty	Reference - Des	Part Description	Manufacturer, Part #
REQUIRED CIRCUIT COMPONENTS:				
1	2	C2,C6	CAP, CHIP, X5R, 10uF, 6.3V, 0603	TDK, C1608X5R0J106M
2	2	C4,C5	CAP, CHIP, X5R, 2.2uF, 4V, 0402	MURATA, GRM155R60G225ME15D
3	1	L1	INDUCTOR, 4.7uH ±20%, 0.254Ω, 1.37A	COILCRAFT, EPL2014-472MLC
4	1	U1	Fixed-Output 400mA Buck Regulator with Dual 150mA LDOS	LINEAR TECH.,LTC3672BEDC-2
ADDITIONAL DEMO BOARD CIRCUIT COMPONENTS:				
1	1	C1	CAP, CHIP, X5R, 10uF, 6.3V, 0603	TDK, C1608X5R0J106M
2	0	C3-OPT	CAP, CHIP, X5R, 2.2uF, 6.3V, 0402	MURATA, GRM155R60J225ME15D
3	1	R1	RES, CHIP, 1.0Ω, ±5%, 1/16W, 0402	VISHAY, CRCW04021R00JNED
HARDWARE FOR DEMO BOARD ONLY:				
1	1	JP1	HEADER, 3 PINS 2mm	SAMTEC, TMM-103-02-L-S
2	1	JP1	SHUNT 2mm	SAMTEC, 2SN-BK-G
3	2	E3, E4	TURRET, 0.061 DIA	MILLMAX, 2308-2
4	8	E1,E2,E5,E6,E7,E8 E9,E10	TURRET, 0.09 DIA	MILLMAX, 2501-2
5	4		STAND-OFF, NYLON 0.375" tall	KEYSTONE, 8832 (SNAP ON)
6	1		FAB, PRINTED CIRCUIT BOARD	DEMO CIRCUIT #1324A

Table 2: Bill Of Materials